

Features

- ESD Protect for 1 Line with Unidirectional
- Provide ESD protection for each line to **IEC 61000-4-2 (ESD) $\pm 30\text{kV}$ (air/contact) Cable Discharged Event (CDE)**
- Suitable for, **24V and below**, operating voltage applications
- Ultra Small package saves board space
- Protect one I/O line or one power line
- Fast turn-on and Low clamping voltage
- Solid-state silicon-avalanche and active circuit triggering technology
- **Green part**
- **AEC-Q101 qualified**

Applications

- Automotive Applications
- Battery Contacts
- Power Line Protection
- Power Manager System
- Portable Devices
- Cellular Handsets and Accessories
- Notebooks, desktops, and servers
- Microprocessor-based equipment
- Peripherals

Description

AZ9424-01F is a design which includes a unidirectional ESD rated clamping cell to protect one power line, or one control line, or one low speed data line in an electronic systems. The AZ9424-01F has been specifically designed to

protect sensitive components which are connected to power and control lines from over-voltage damage and latch-up caused by Electrostatic Discharging (ESD) and Cable Discharge Event (CDE).

AZ9424-01F is a unique design which includes proprietary clamping cell in a single package. During transient conditions, the proprietary clamping cell prevents over-voltage on the power line or control/data lines, protecting any downstream components.

AZ9424-01F may be used to meet the ESD immunity requirements of IEC61000-4-2, Level 4 ($\pm 15\text{kV}$ air, $\pm 8\text{kV}$ contact discharge).

Circuit Diagram / Pin Configuration

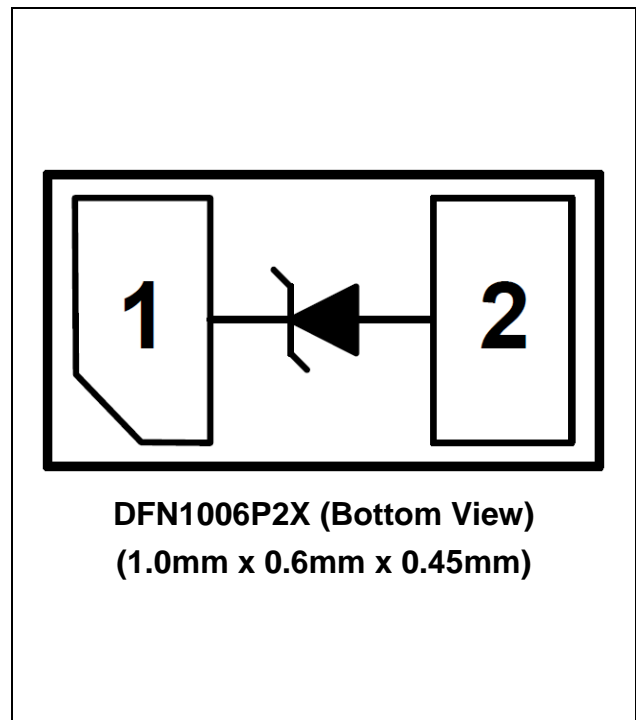



SPECIFICATIONS

ABSOLUTE MAXIMUM RATINGS			
PARAMETER	SYMBOL	RATING	UNITS
Operating Supply Voltage	V_{DC}	26.4	V
ESD per IEC 61000-4-2 (Air)	V_{ESD}	± 30	kV
ESD per IEC 61000-4-2 (Contact)		± 30	
Lead Soldering Temperature	T_{SOL}	260 (10 sec.)	$^{\circ}C$
Operating Temperature	T_{OP}	-55 to +125	$^{\circ}C$
Storage Temperature	T_{STO}	-55 to +150	$^{\circ}C$

ELECTRICAL CHARACTERISTICS						
PARAMETER	SYMBOL	CONDITIONS	MINI	TYP	MAX	UNITS
Reverse Stand-Off Voltage	V_{RWM}	Pin-1 to pin-2, $T=25^{\circ}C$.			24	V
Reverse Leakage Current	I_{Leak}	$V_{RWM} = 24V$, $T=25^{\circ}C$, pin-1 to pin-2.			1	μA
Reverse Breakdown Voltage	V_{BV}	$I_{BV} = 1mA$, $T=25^{\circ}C$, pin-1 to pin-2	27		33	V
Forward Voltage	V_F	$I_F = 15mA$, $T=25^{\circ}C$, pin-2 to pin-1	0.5		1.2	V
ESD Clamping Voltage (Note 1)	V_{clamp}	IEC 61000-4-2 +8kV ($I_{TLP} = 16A$), Contact mode, $T=25^{\circ}C$, pin-1 to pin-2.		42		V
Channel Input Capacitance	C_{IN}	$V_R = 0V$, $f = 1MHz$, $T=25^{\circ}C$.		42	50	pF

Note 1: ESD Clamping Voltage was measured by Transmission Line Pulsing (TLP) System.

TLP conditions: $Z_0 = 50\Omega$, $t_p = 100ns$, $t_r = 1ns$.



Typical Characteristics

Transmission Line Pulsing (TLP) Measurement

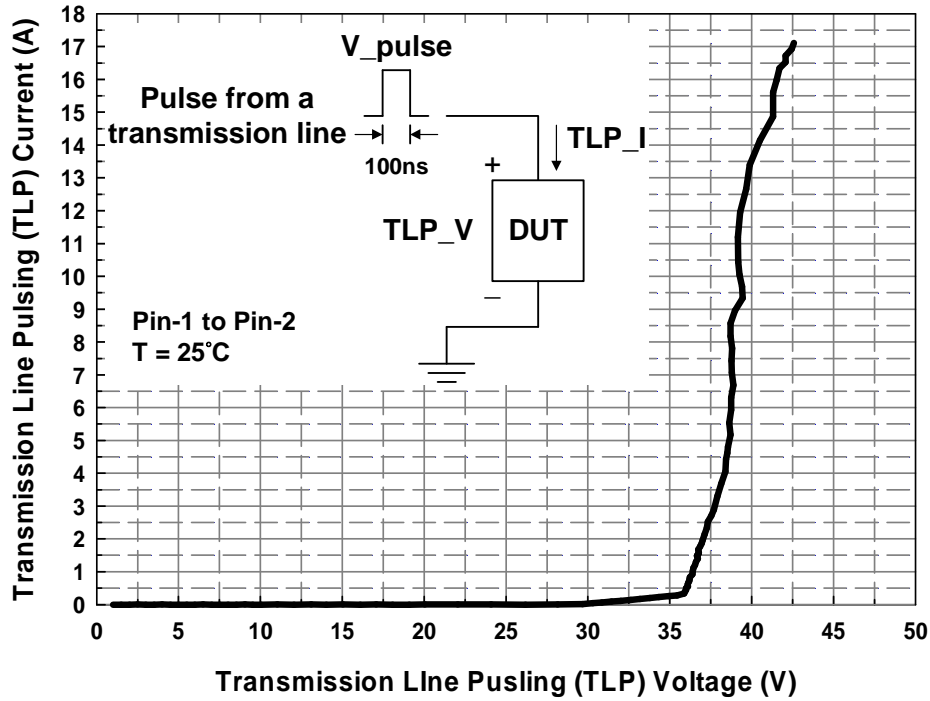

Typical Variation of C_{IN} vs. V_{IN}

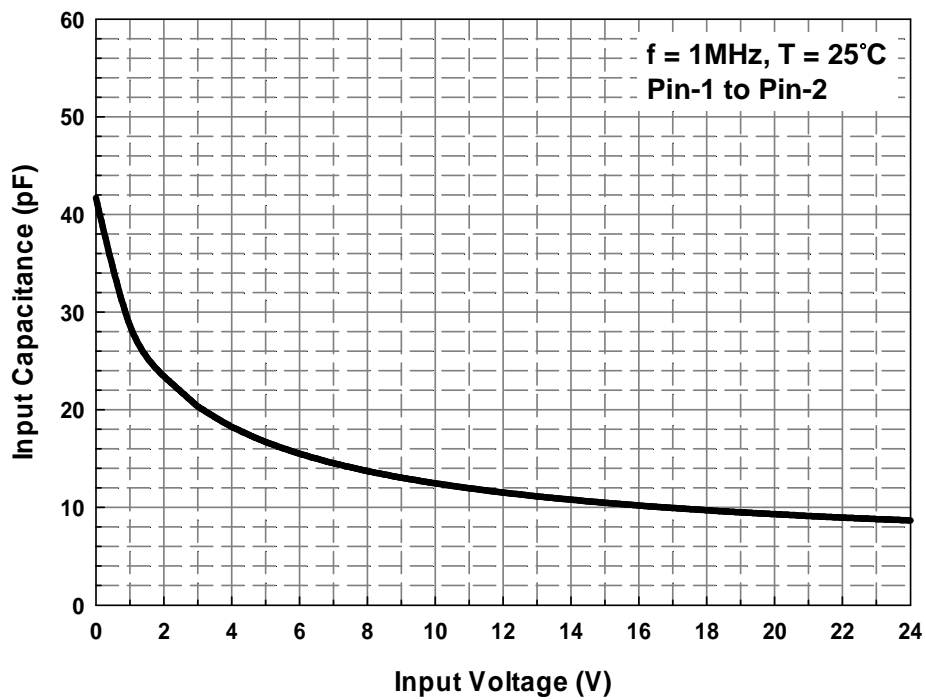

Applications Information

The AZ9424-01F is designed to protect one line against System ESD pulses by clamping them to an acceptable reference.

The usage of the AZ9424-01F is shown in Fig. 1. Protected lines, such as data lines, control lines, or power lines, are connected at pin 1. The pin 2 should be connected directly to a ground plane on the board. All path lengths connected to the pins of AZ9424-01F should be kept as short as possible to minimize parasitic inductance in the board traces.

In order to obtain enough suppression of ESD induced transient, good circuit board is critical. Thus, the following guidelines are recommended:

- Minimize the path length between the protected lines and the AZ9424-01F.
- Place the AZ9424-01F near the input terminals or connectors to restrict transient coupling.
- The ESD current return path to ground should be kept as short as possible.
- Use ground planes whenever possible.
- NEVER route critical signals near board edges and near the lines which the ESD transient easily injects to PCB internal circuit.

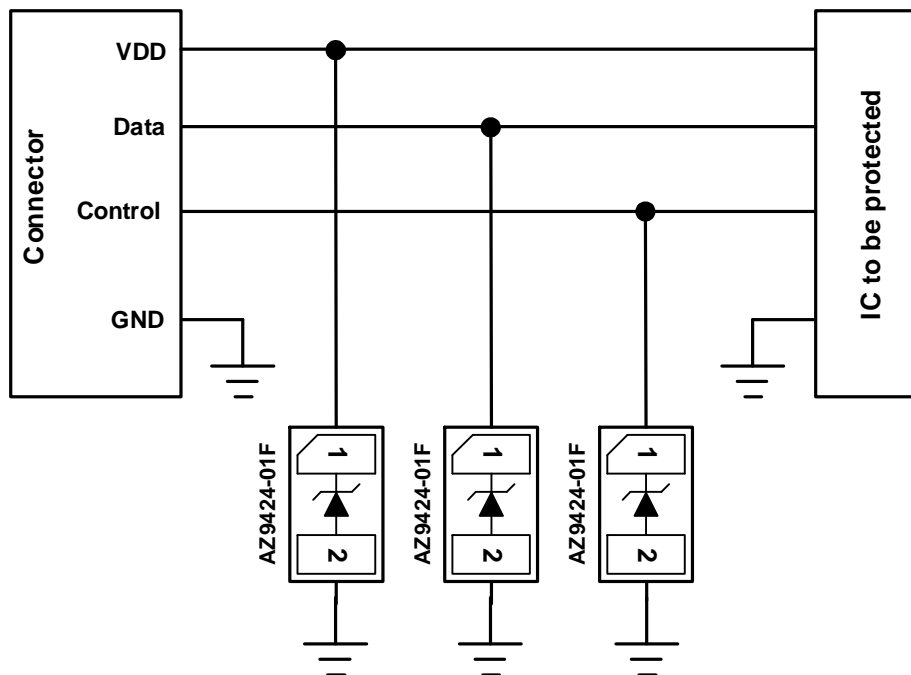

Fig. 1 ESD protection scheme by using AZ9424-01F.



Mechanical Details

DFN1006P2X

PACKAGE DIAGRAMS

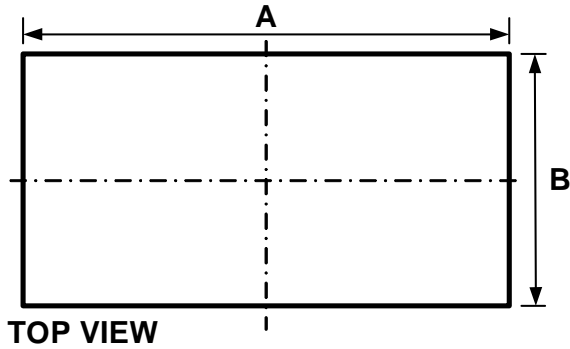

TOP VIEW



SIDE VIEW

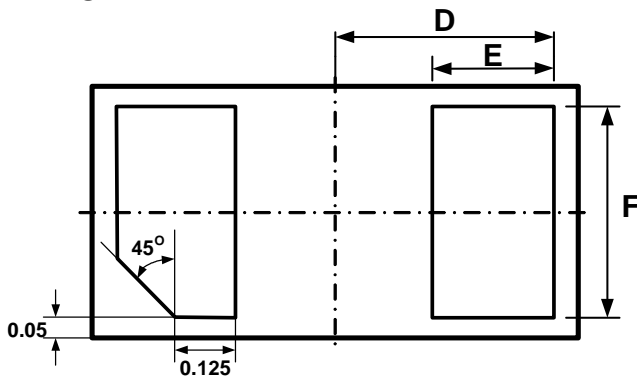

BOTTOM VIEW

LAND LAYOUT

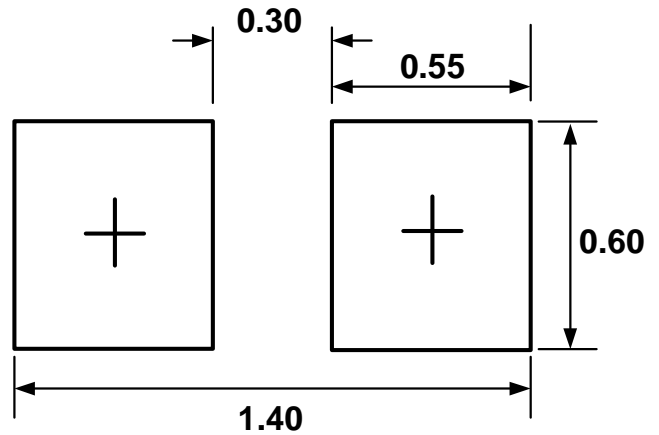

Notes:

This LAND LAYOUT is for reference purposes only. Please consult your manufacturing partners to ensure your company's PCB design guidelines are met.

MARKING CODE

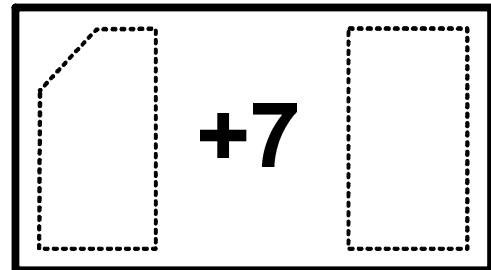

Top View

Symbol	Millimeters		Inches	
	min	max	min	max
A	0.95	1.05	0.037	0.041
B	0.55	0.65	0.022	0.026
C	0.41	0.55	0.016	0.022
D	0.45		0.018	
E	0.20	0.30	0.008	0.012
F	0.45	0.55	0.018	0.022

Part Number	Marking Code
AZ9424-01F (Green part)	7

Note. Green means Pb-free, RoHS, and Halogen free compliant.



Ordering Information

PN#	Material	Type	Reel size	MOQ	MOQ/internal box	MOQ/carton
AZ9424-01F.R7GR	Green	T/R	7 inch	12,000/reel	4 reel = 48,000/box	6 box = 288,000/carton

Revision History

Revision	Modification Description
Revision 2015/04/09	Preliminary Release.
Revision 2015/12/07	Formal Release.